

Fisketeine: Utviklingsarbeidet ved HI



HAVFORSKNINGSINSTITUTTET
INSTITUTE OF MARINE RESEARCH



Svein Løkkeborg
Faggruppe Fangst

Teine:

Mange fordeler - få ulemper

Positivt:

- Miljøvennlig
- Energivennlig
- Lave kostnader
- Lite arbeidskrevende
- Super kvalitet
- Tåler lang ståtid
- Levendefangst

Negativt:

- Ghostfishing
- Lav fangsteffektivitet



Sammenleggbart teine

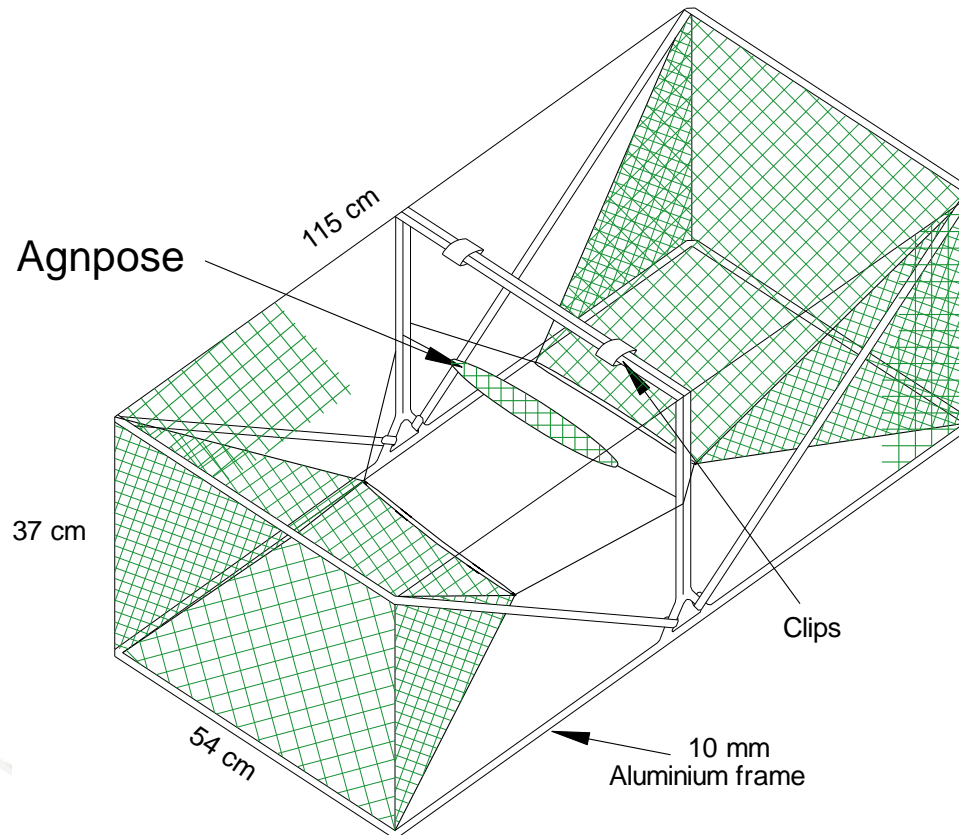

- Effektiv for brosme
- Men, for lave fangster av torsk



Utvikling av teineteknologi

- Dobbel kalv/inngang
- Tokammerteina
- Fløyta teine
- En kalv/inngang
- Kalvutforming
- Lys
- Streamer
- Område og sesong



Smal inngang – et hinder for torsk



Torsk – en Gjest Baardsen



Dobbel kalv: en vid og smal

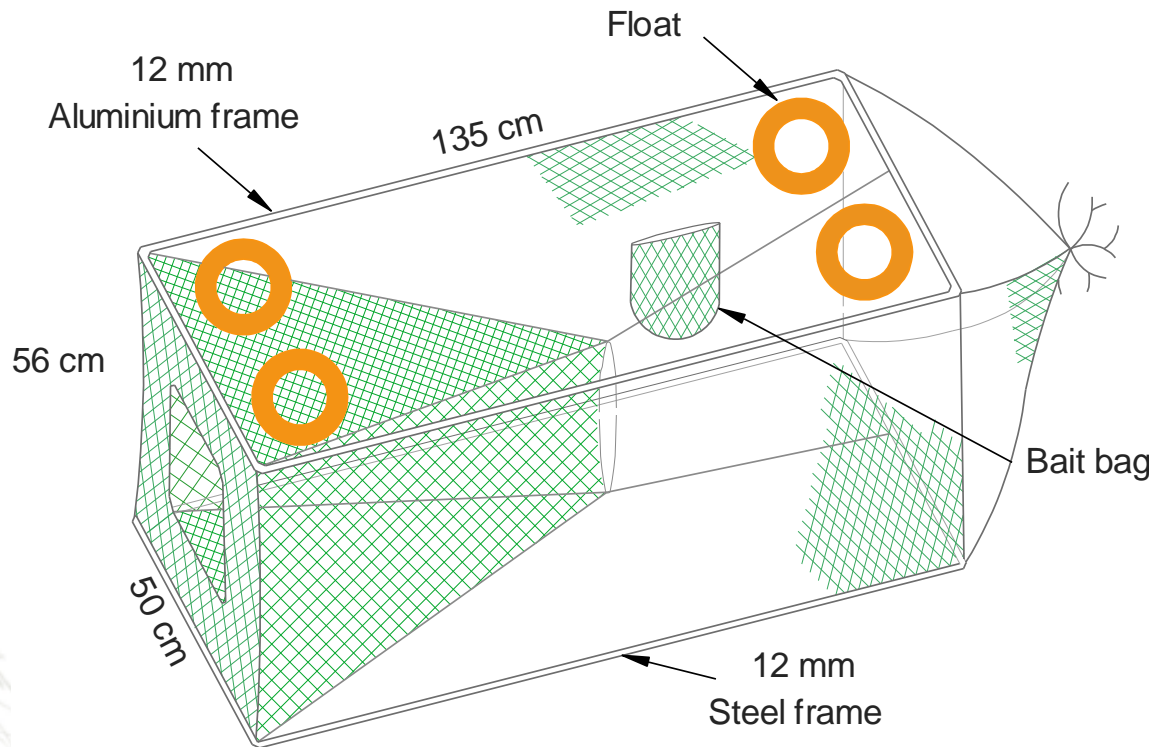

Problem:
Plassering av
agnposen

Ga 3-dobling av torskefangstene, men fortsatt for lave



Viktig: agnposens plassering



Vertikal søkeatferd: opp og ned



Tokammerteina



Ga 15 ganger høyere torskefangster



”*Men*, disse f.... krabbene!



Fløyta teine

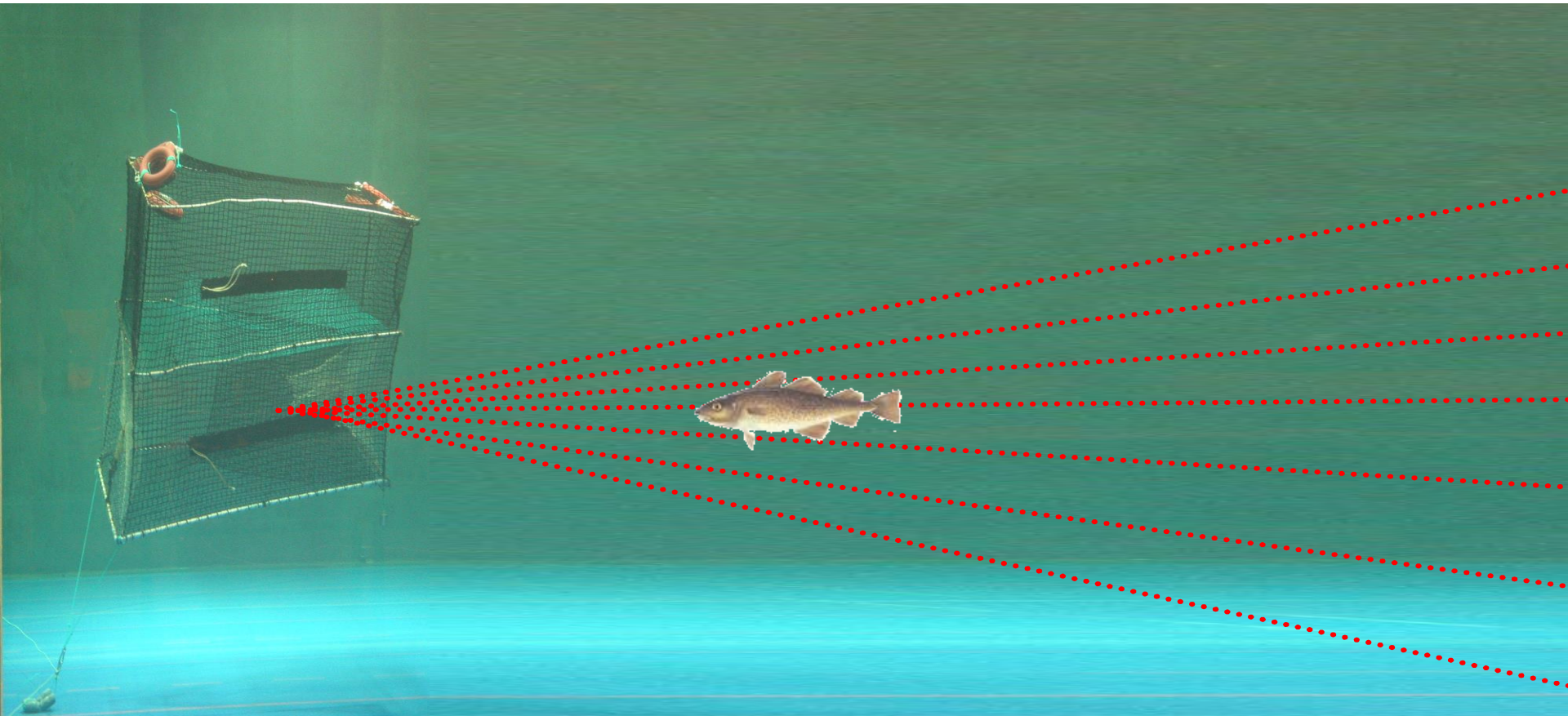

Fløyta mot bunnsatte teiner:

45% fangstøkning

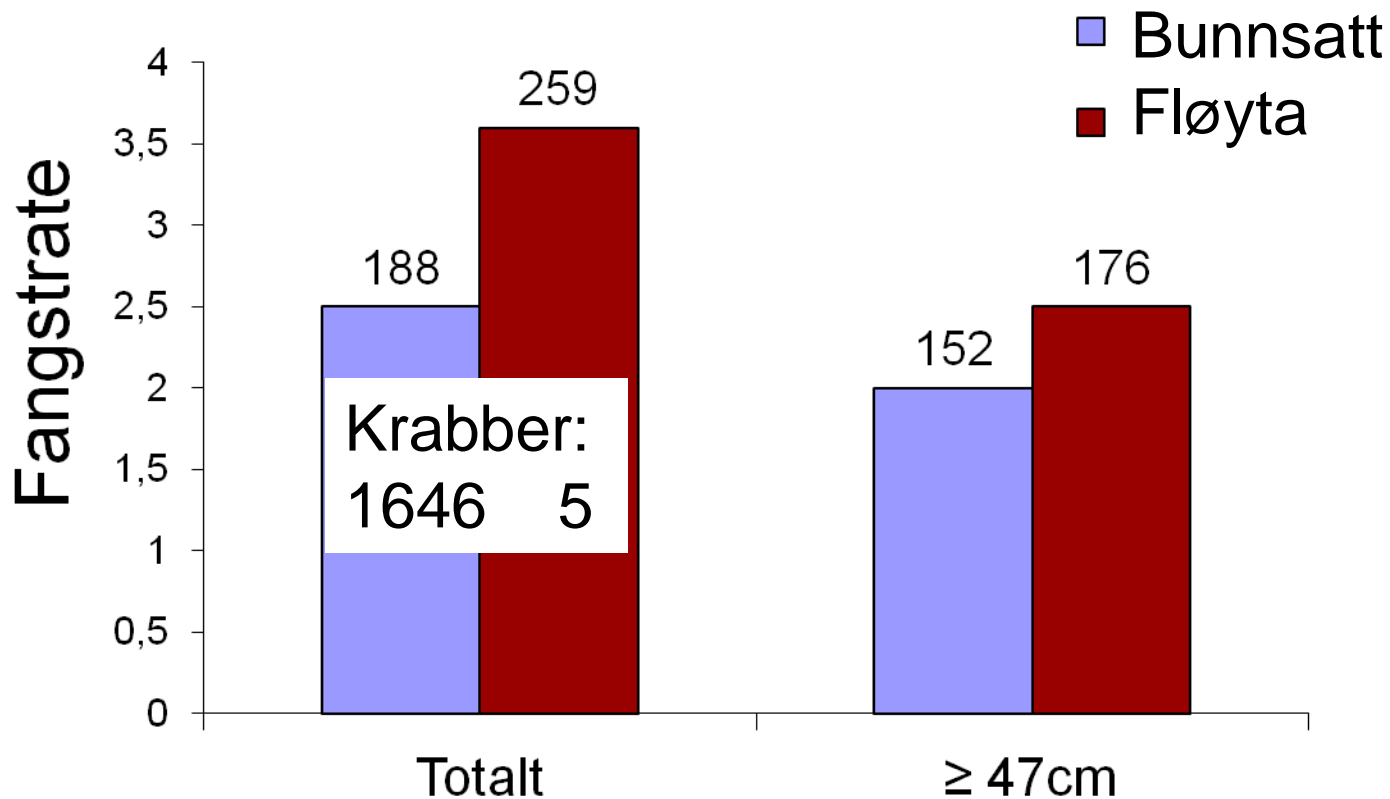

Svømmeretning

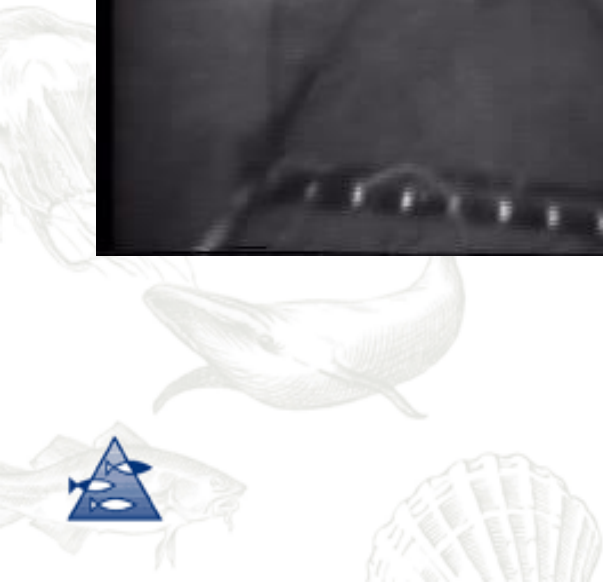

Svømmeretning – Bunnsatt teine

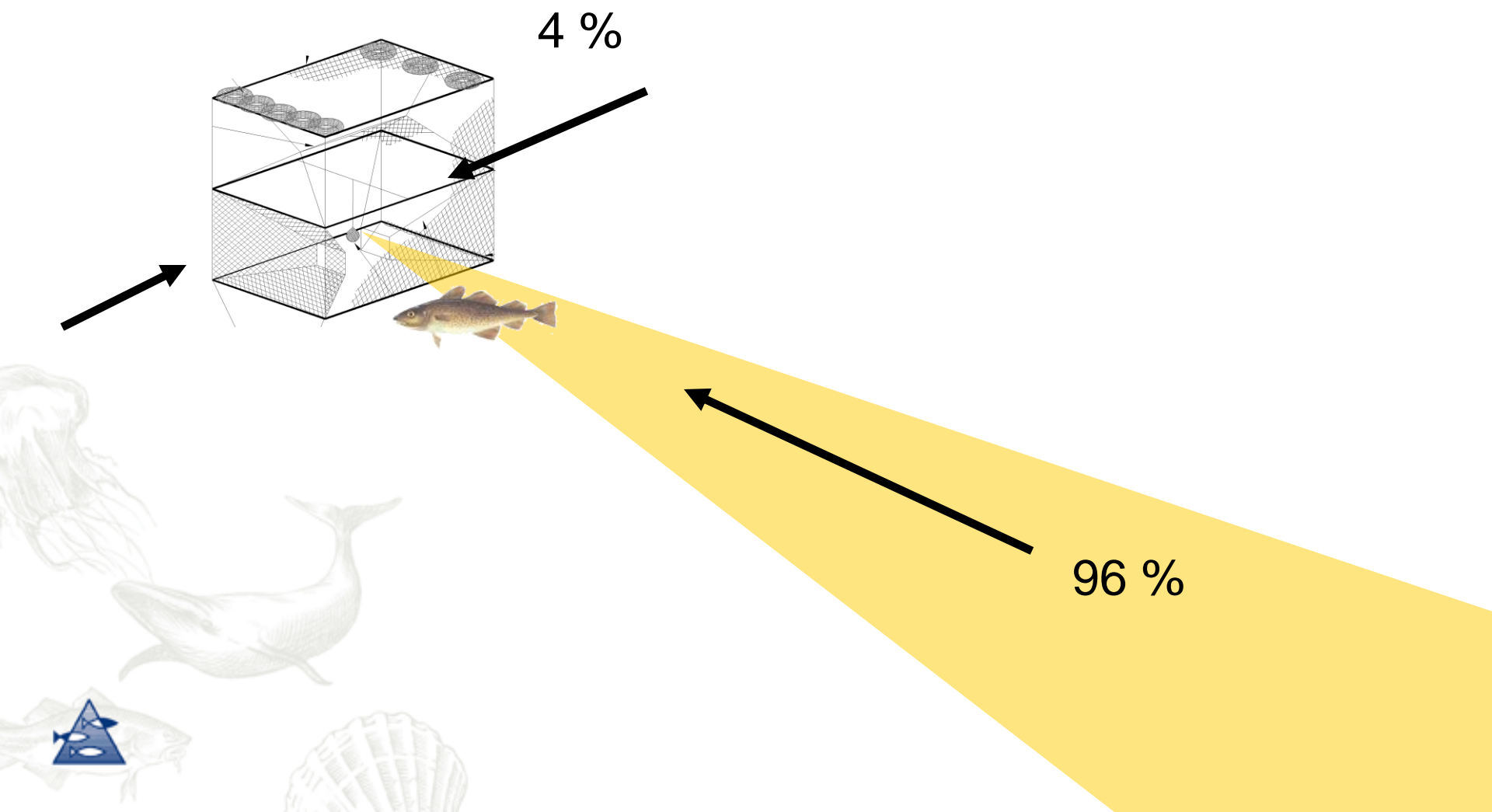

Svømmeretning – Fløyta teine

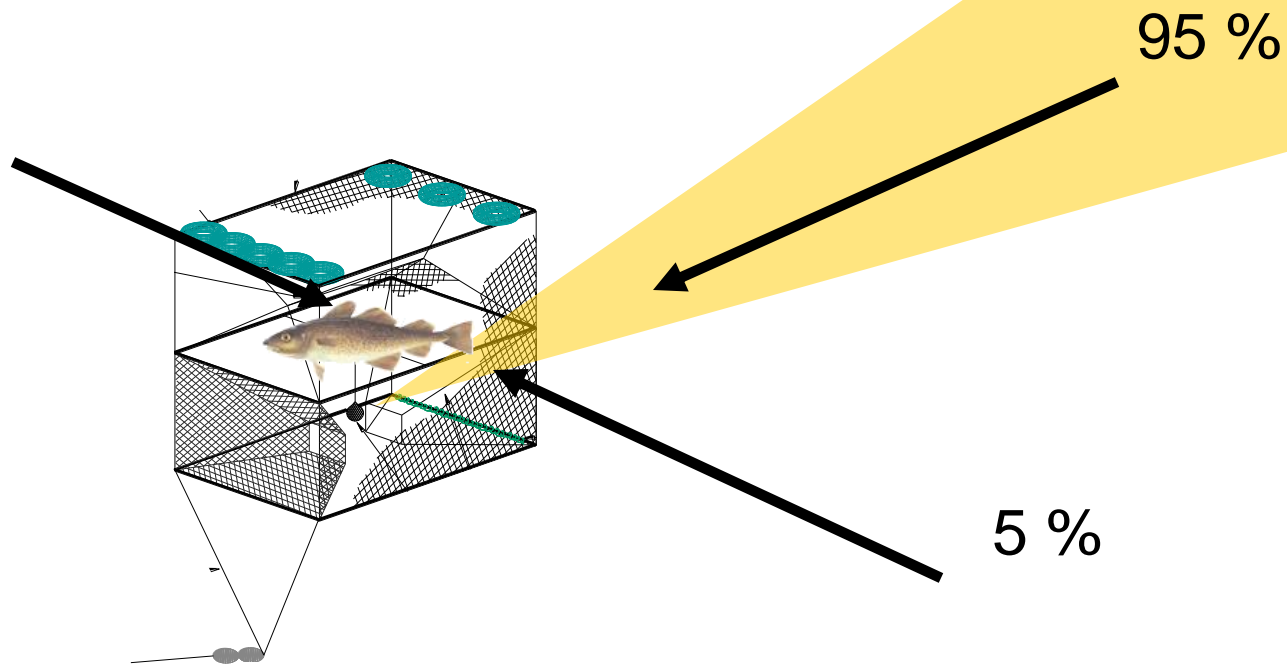

Fløyta teine: En mot to innganger

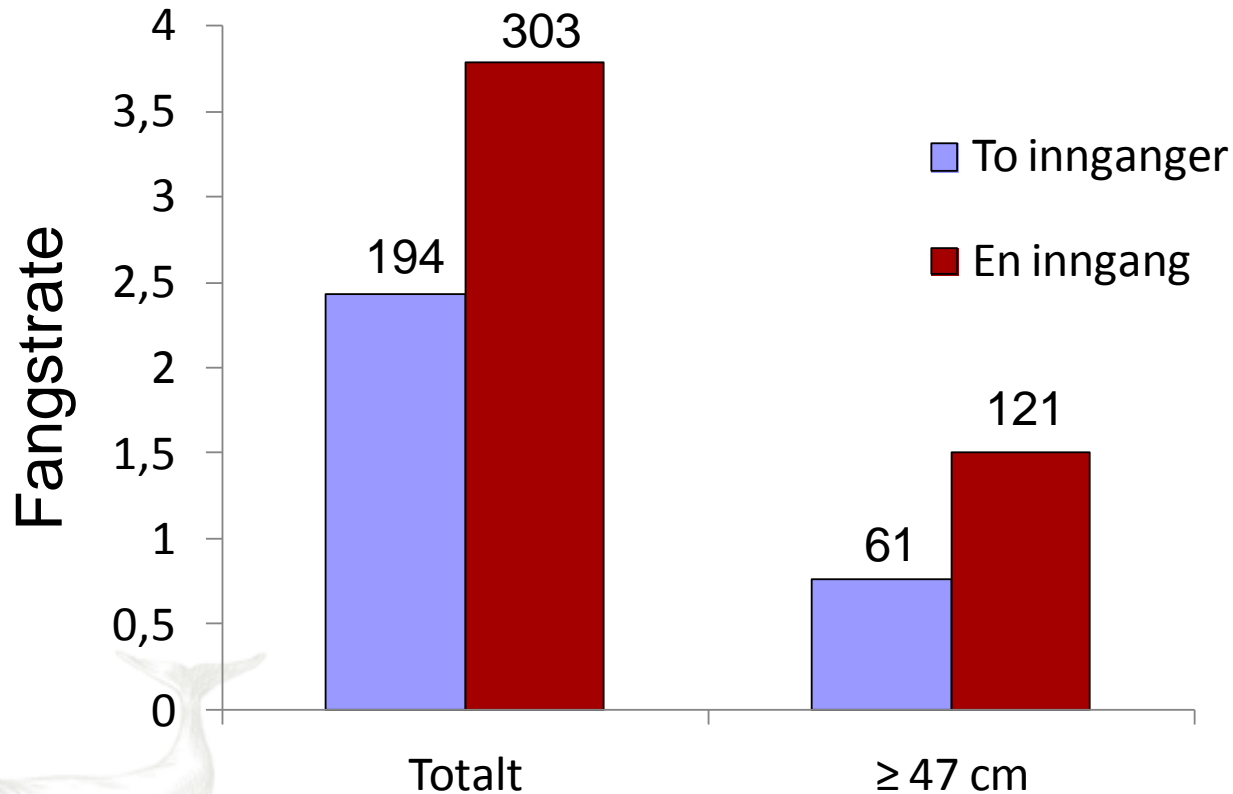

Lys

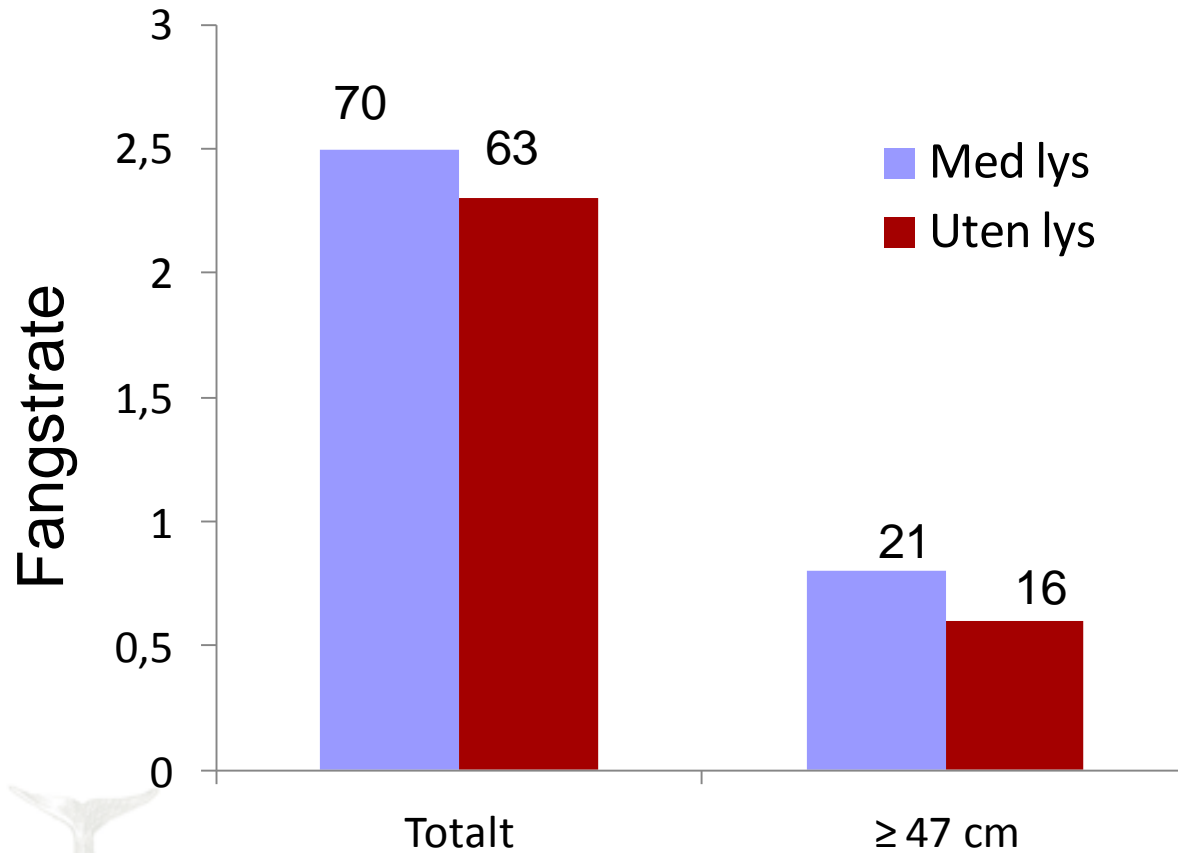

Ingen, *men* veldig svakt lys

Newfoundlandteina

2 m x 2 m x 1 m

16 mm stålstenger

Kalv (43 cm) med spiler

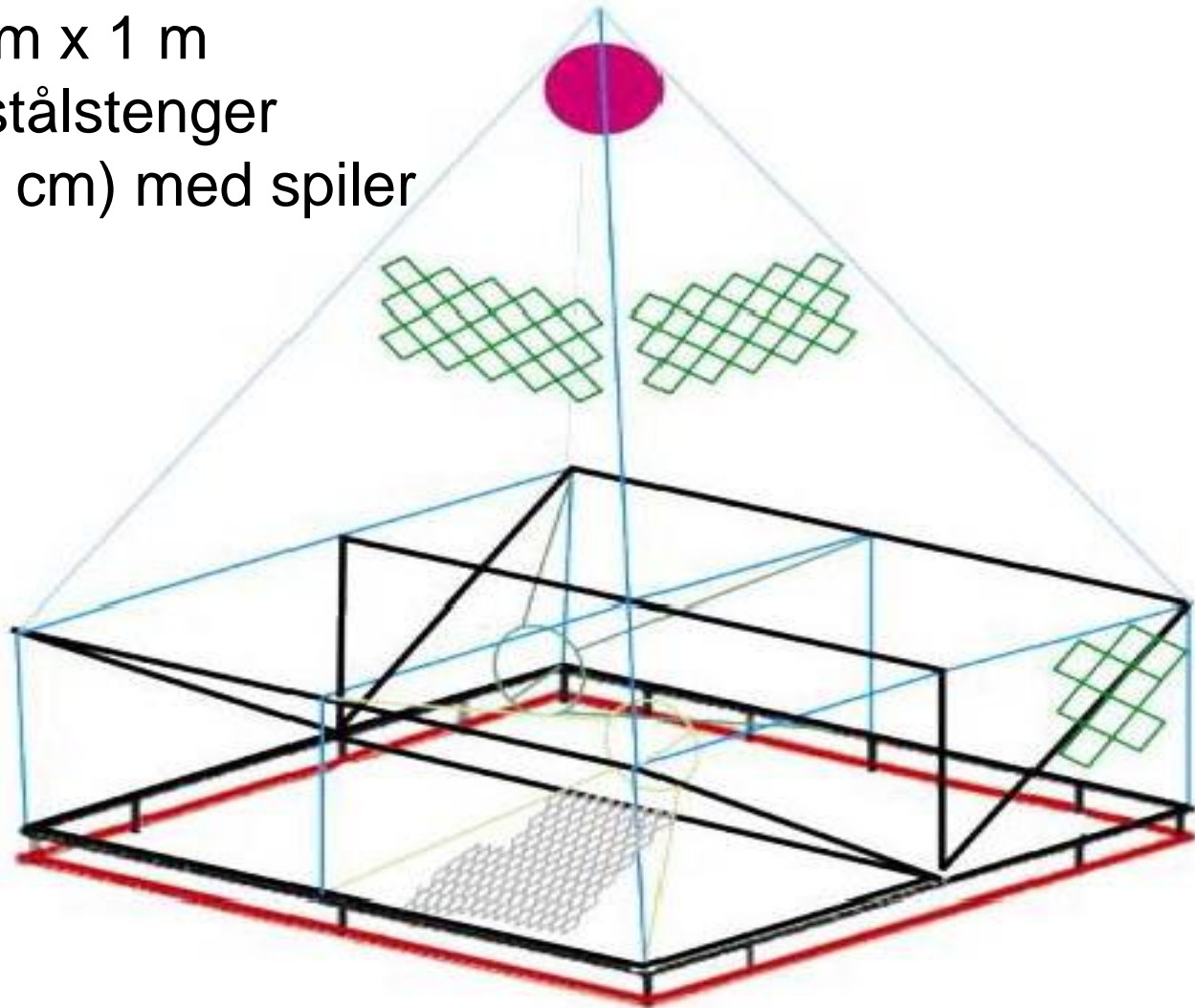

Newfoundlandteina

Oppnådde resultater:

- Fisker best om høsten (lite mat i sjøen)
- Fangstrater opptil 50-100 torsk per teine (200 kg)
- God kvalitet og høyere priser (+ 3 kr.)
- Tatt i bruk blant kystfiskere (tidligere garn)



Båtsfjord, juni 2012:

Newfoundlandteina og tokammerteina

Teinetype	Antall torsk	Fangstrate
Newfoundland	4	0,1
Fløyta	30	0,5
Bunnsatt	92	1,5

Fangst line, ant. torsk per 100 krok: 2,4



Hvorfor fiska tokammerteina bedre?

Tokammerteina

- Liten inngang
- Uten spiler
- To kammer
- Agnpose ved inngangen
- Orientert etter strømmen
- Fleksibel og bevegelig
- Liten

Newfoundlandteina

- Stor og vid inngang
- Med spiler
- Ett kammer
- Agnpose i sentrum
- Tilfeldig orientering
- Rigid og stabil
- Stor



Vesterålen, april 2013:

Newfoundlandteina og tokammerteina

Nr.	1	2	3	4	5	6	7	8	9	10	11	12	13	14
N				20		16				6	16	8	15	7
F				31		28				18	18	32	31	28
B				18		21				23	13	17	42	30



Vesterålen, april 2013:



Teinetype: “Lofotenteina”



- 2,5 x 2,5 x 3,2 m
- Konstruert av Ole Vegar Mosseng ved Lofoten Sjøprodukter
- Rigid tokammerteine i aluminium
- Utviklet for bruk rundt anlegg

Ansamling av fisk ved oppdrettsanlegg



Grunt:
20-40 m

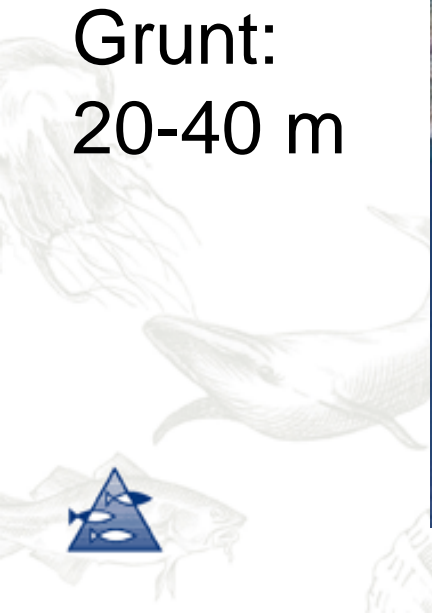

Snittfangster per teine:

Ved anlegget 100 m fra Forholdstall

Sei:

Lofotenteine	150,9	11,5	13
Stor tokammer	40,9	5,0	8
Vanlig tokammer	10,1	1,5	7

Torsk:

Lofotenteine	12,9	1,8	7
Stor tokammer	6,3	1,8	3,5
Vanlig tokammer	3,4	0,8	4

Max fangst i Lofotenteina: 1,3 tonn sei!



Konklusjon og videre arbeid

- Område - Sesong
- Størrelse
- Rigid – fleksibel
- Kalvutforming
- Andre stimuli - Lys
- Langtidsvirkende agn



Verden går videre og ting utvikler seg,
det tar bare litt tid

